

# Graphic Square 069308-1



① x4



② x1

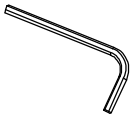

DX1



CX1

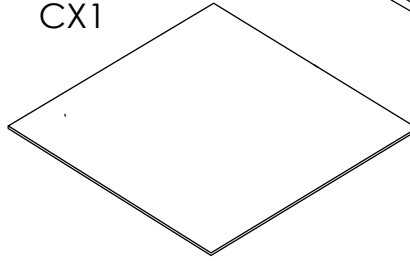

AX1

BX1

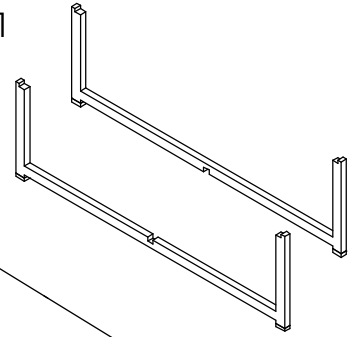

1

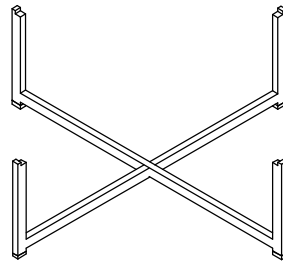
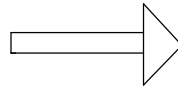
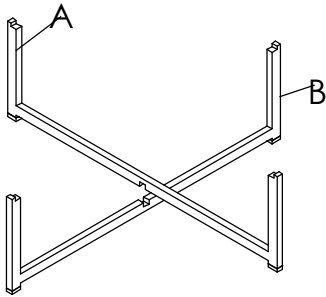

2

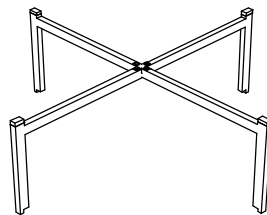
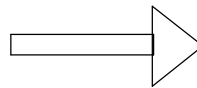
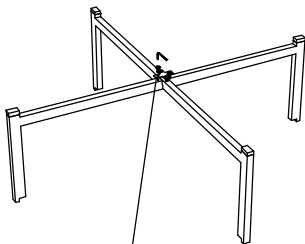

3

